

ASC219C

Features: (typical values)

- Very high IP3 +40 dBm.
- High P1dB 26.0 dBm.
- Low NF @ 100-2000mhz 3.5 dB.
- Super low cost
- No external components required

Maximum Ratings

Storage Temperature -62°C to +125°C
 DC Voltage +17 volts
 RF Input Power +20.0 dBm.
 Case Temperature +95°C

**10-2000 MHz
Wideband Amplifier**

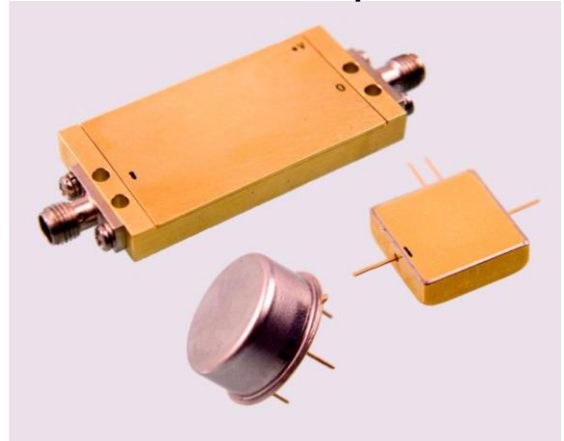

Specifications (Referenced to 50 ohms)

Parameter	Typical Conditions	Min Value	Max Value	Units
Frequency		10	2000	MHz.
Gain	11.0	10.0		dB.
Gain Flatness	±0.5		±0.8	dB.
Gain Var. over temp	0.7			ΔdB.
Pout @ 1dB Comp	+26.5	+25.0		dBm.
NF 100-2000mhz	3.5		5.5	dB.
Reverse Isolation	16.0			dB.
IP ₃ /IP ₂ (two-tone)	40/46	35/40		dBm.
HIP2 (2 nd harm.)	52.0			dBm.
VSWR In/Out	1.7:1		2.0:1	
Supply Required	+15/190		+15/200	v/mA.

Min. and max. values are from -55°C to +85°C

OUTLINE

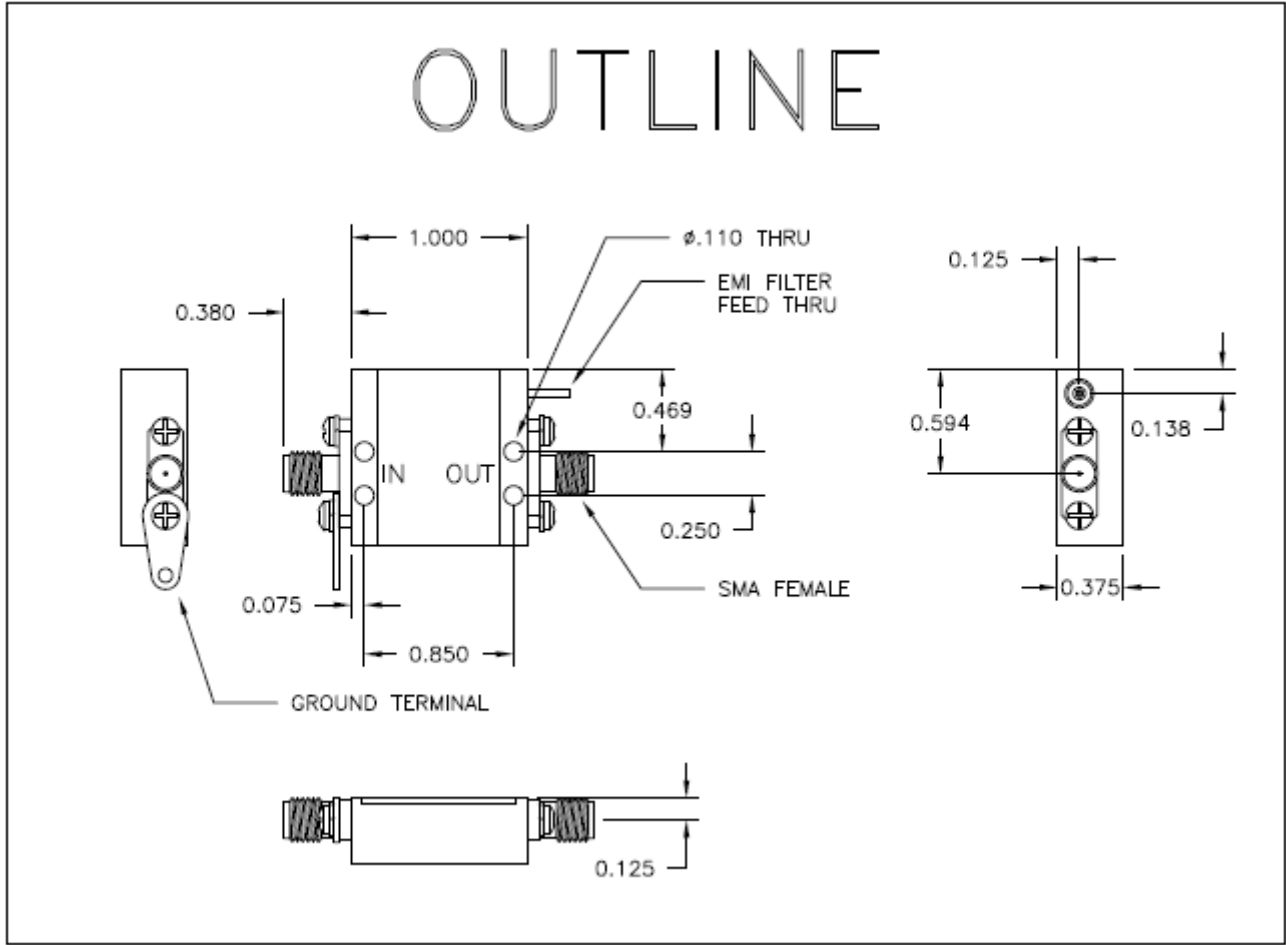

Typical Performance Curves

■ -55°C ◆ -+25°C ▲ -+85°C

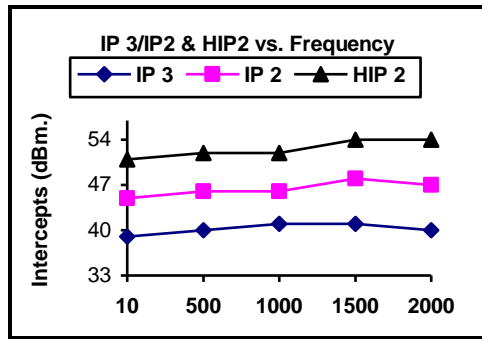
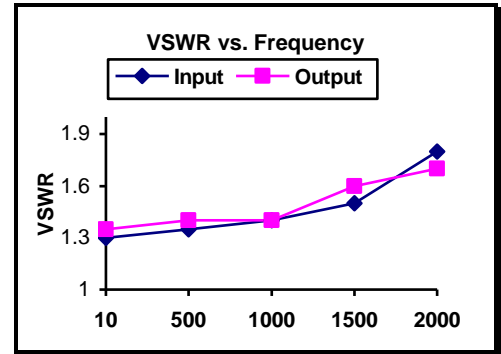
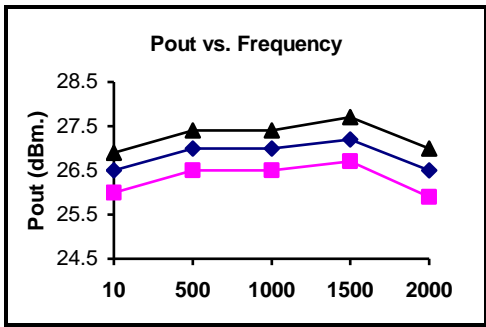
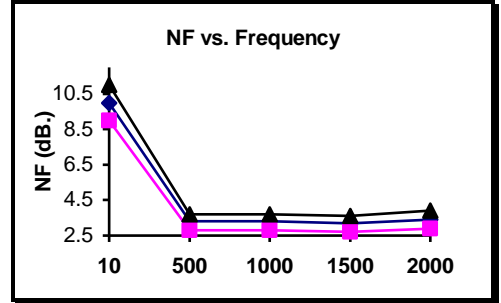
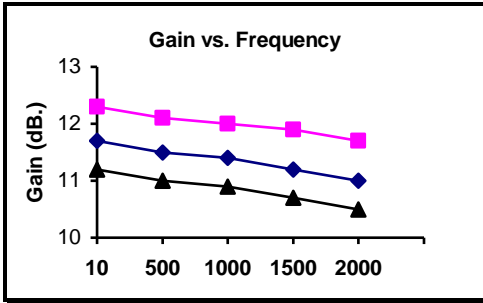

FINAL ELECTRICAL TEST REPORT
RECORD DATA @ +25°C ONLY

TEST Vdc +15V	LIMITS -55°C/+25°C/+85°C	ACTUAL DATA
Gain 10 to 2000 MHz	10 dB min	12.0 12.6
Gain Flatness 10 to 2000 MHz	± 0.8 dB max	±0.3
Gain Variation Over Temp. 10 to 2000 MHz	0.7 dB typ	/
Reverse Isolation 10 to 2000 MHz	16 dB typ	20
DC Current at +15 Vdc	200 mA max	169
Input VSWR 10 to 2000 MHz	2.0 : 1 max	1.68
Output VSWR 10 to 2000 MHz	2.0 : 1 max	1.76
Noise Figure 100 to 2000 MHz	5.5 dB max	4.3
P 1.0 dB Compression 10, 1000 & 2000 MHz	25 dBm min	26.0
IP3 with Pout = +15.0 dBm each tone 1) F1/F2=11/12 MHz Fc=10&13 MHz 2) F1/F2=998/999MHz Fc=997&1000MHz 3) F1/F2=1998/1999MHz Fc=1997&2000MHz	35.0 dBm min	40.0
IP2 with Pout = +15.0 dBm each tone 1) F1-F2=500-490 Fc=10MHz 2) F1+F2=499+501 Fc=1000MHz 3) F1+F2=999+1001 Fc=2000MHz	40.0 dBm min	50.0
Stability Test : For all frequencies Where $ S_{21} > 0\text{dB}$	0 dB max	<0

FUNCTIONAL BLOCK DIAGRAM

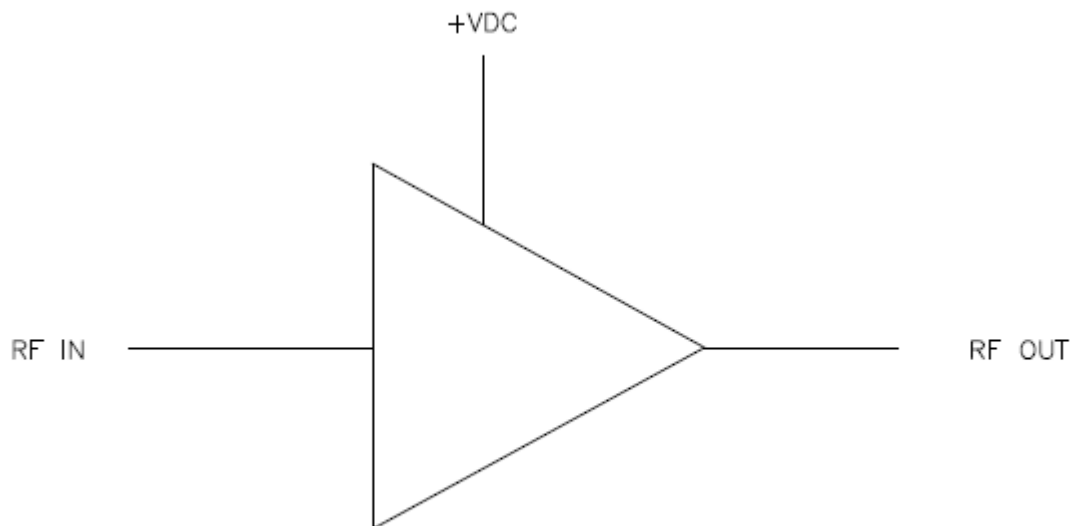

NO EXTERNAL COMPONENT REQUIRED